

CS15 Series AC-DC Converter



Features

- UL, CE Approved
- RoHS directive compliance
- Encapsulated, compact case
- High efficiency
- Universal input(AC85~264V or DC110~340V)
- Surface mounting technology
- Built in EMI filter
- Inrush current limit
- 100kHz fixed frequency
- Fixed output voltage
- Thermal shutdown(IC-Temp: 140°C Min.)
- Low output ripple & noise
- Isolated input-output(3kVAC)
- Output short circuit protection
- Over voltage protection(O.V.P.)
- Over current protection(O.C.P.)
- 2Years warranty

Environmental

- Operating temperature range: -10°C~60°C
- Storage temperature range: -20°C~70°C
- Humidity: 20%~90%RH
- Vibration: 10~55Hz at 10G(98m/s²), 3minutes period, 60minutes each one X, Y and Z axis
- Impact: 50G(490m/s²), 11ms, once each
- Cooling method: natural air convection
- MTBF(MIL-HDBK-217F): 2.1*10⁵hours

Safety

- UL (UL60950, CSA C22.2 NO.60950)
- UL No: E227474
- CE(EN60950) – through TÜV

Description

The CS15 Series has universal AC input and there are 5 models with single output. High reliability are achieved. A built in EMI filter is reduced the noise level .

CS15 Series AC-DC Converter

Electrical specifications		
INPUT	Voltage	AC85~264V (or DC 110~340V) 50/60Hz (note)
	Current	0.49A Max. @ 110VAC / 0.25A Max. @ 220VAC
	Frequency	47~440Hz Max. (50~60Hz typ.)
	Efficiency	80% Typ.
	Inrush current (at cold start)	30A Max. @ 120VAC. / 60A Max. @ 240VAC
	Leakage current	0.5mA Max. @ 110VAC / 0.75mA Max. @ 220VAC
OUTPUT	Voltage tolerance (accuracy)	±2% Max.
	Ripple and noise	±1% Typ.
	Line regulation	±1% Typ.
	Load regulation	±1% Typ.
	Dynamic load regulation	±3% Typ.
	Temperature regulation	±1% Typ.
	Rising time	400ms Max.
	Hold up time	10ms Min.

Protection circuit	
Over current protection	Works at over 105% of rating & recovers automatically
Over temperature protection	PWM IC-Temperature 140°C Min. Latching, Recovering

Isolation specifications	
Isolation Resistance	DC 500V, 100MOhms Min.
Input-Output Isolation Voltage	AC 3KV, 1minute, 10mA.
Input-FG	AC 2KV, 1minute, 10mA.
Output-FG	AC 0.5KV, 1minute, 10mA.

General specifications	
Switching frequency	100kHz
Calculated MTBF	2.1*10 ⁵ hours
Weight	210g or less

NOTE: For cases that conform various safety specifications(UL, CSA, CE etc). It require input voltage and frequency range will be 100~240Vac, 50~60Hz.

CS15 Series AC-DC Converter

Ordering information

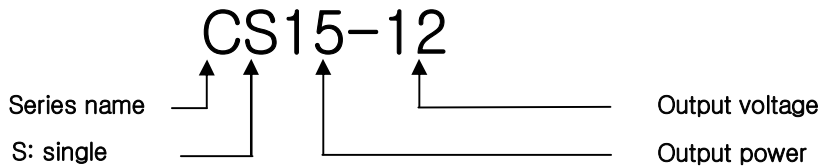

Input	Output	Maximum power	Ripple & Noise	Efficiency typical	Model number
AC90~264V or DC120~340V	3.3V@3.0A	9.90W	30mVp-p	70%	CS15-3R3
	5V@3.0A	15.00W	50mVp-p	71%	CS15-5
	12V@1.25A	15.00W	80mVp-p	72%	CS15-12
	15V@1.0A	15.00W	80mVp-p	77%	CS15-15
	24V@0.63A	15.12W	100mVp-p	79%	CS15-24

Pin assignments

- Single output Connector
1. AC(L)
2. AC(N) CN1
3. F.G.
4. -V
5. +V

Derating curve

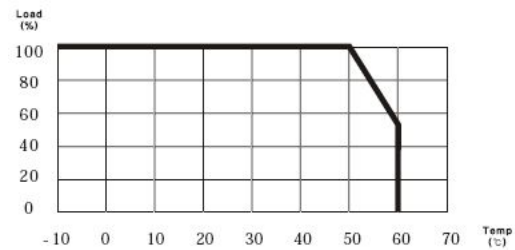

Dimensions

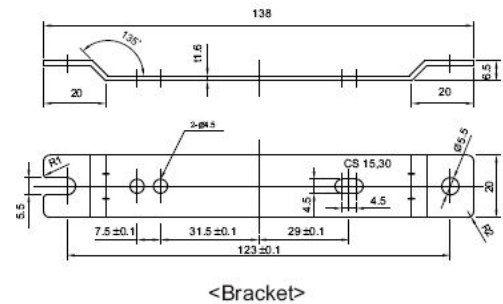
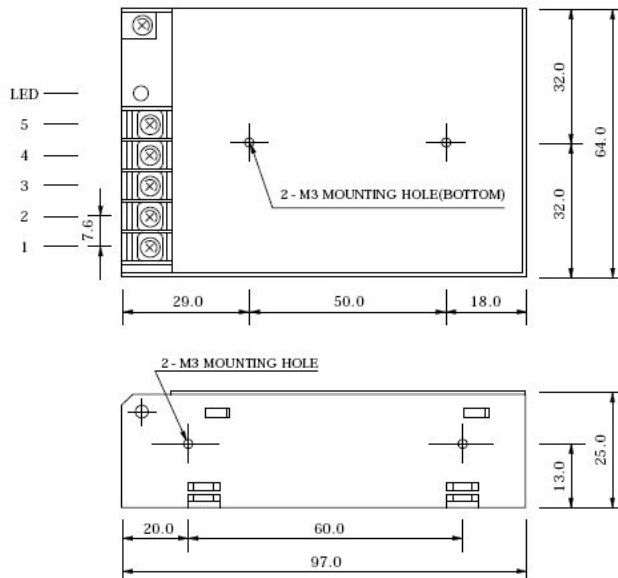

NOTES

- All dimensions are mm.
- Weight : 210g or less (single)
- Mounting holes(4) for M3 screw, which should not enter the supply surface by more than 2.5mm.

CS15 Series AC-DC Converter

Inrush Current

TEST CONDITION

- 240Vac input
- Full load output
- PHASE 90° input start, current measure

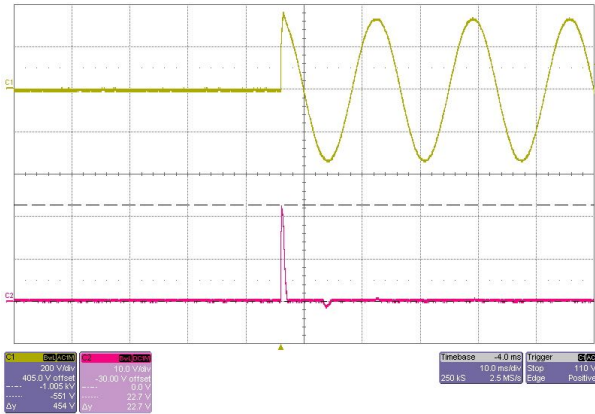

CS15-3R3 22.7A

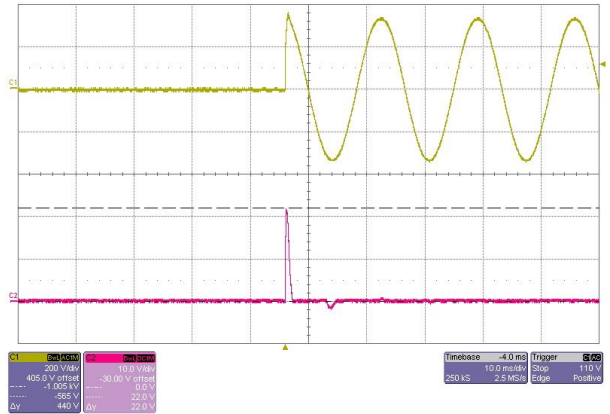

CS15-5 22.0A

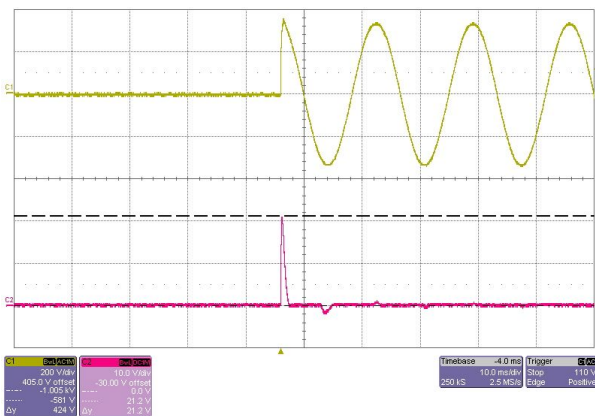

CS15-12 21.2A

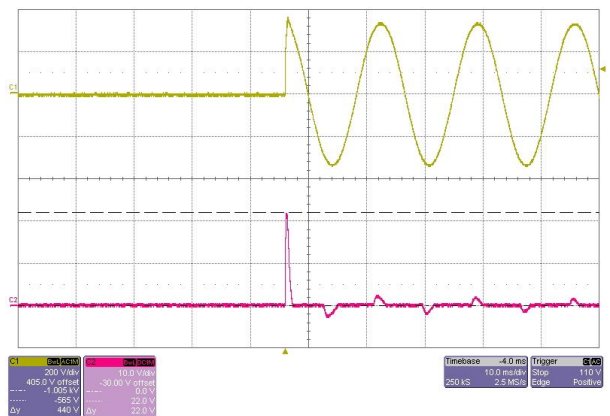

CS15-15 22.0A

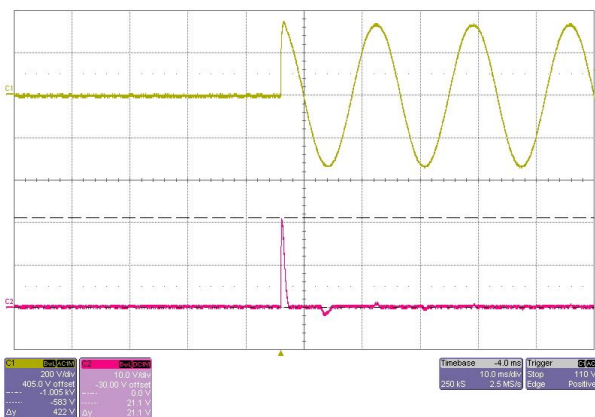

CS15-24 21.1A

Inrush current concerns wrong to fuse, input rectifier, power-switch, circuit break and parts. It degrades the another circuit voltage and occurs system error. If you defuse inrush current.

You add NTC or Inrush current limiter to external circuit.

High rating voltage input

Max30A @ 120Vac

Max60A @ 240Vac

CS15 Series AC-DC Converter

Rising Time

TEST CONDITION

- 100Vac Input
- Full Load Output
- Output Voltage 10% ~ 90% Rising Time Measure

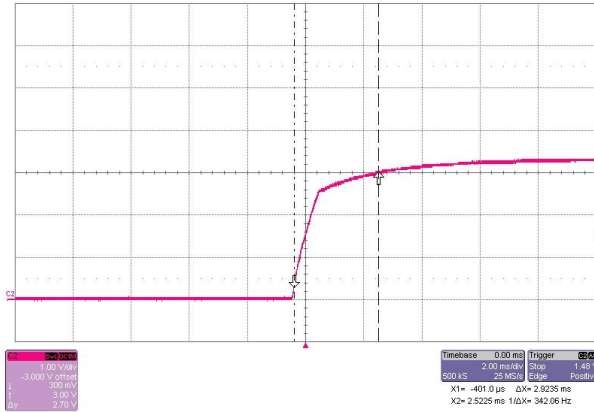

CS15-3R3 2.9mS

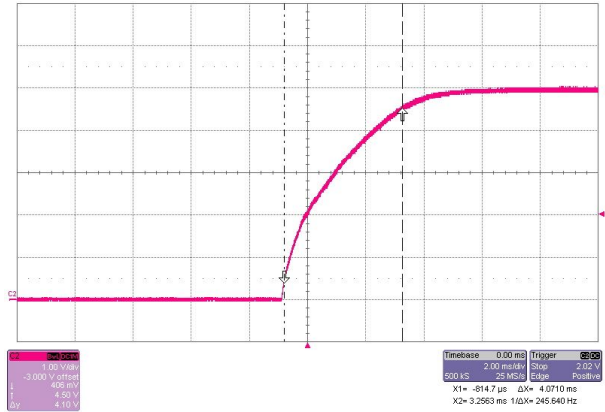

CS15-5 4.1mS

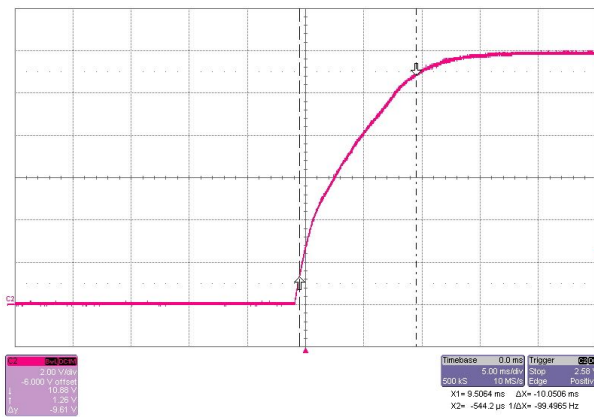

CS15-12 10.1mS

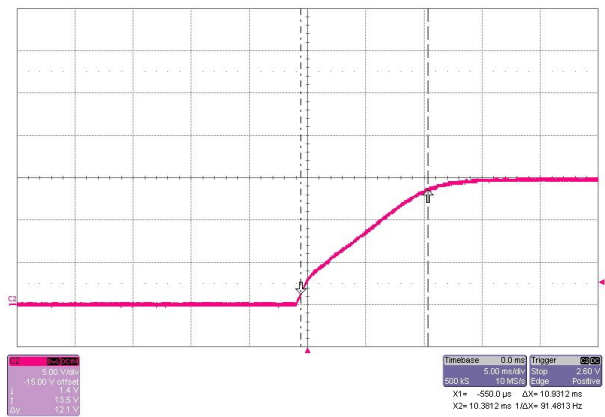

CS15-15 10.9mS

Max 100ms between output voltage 10%~90%

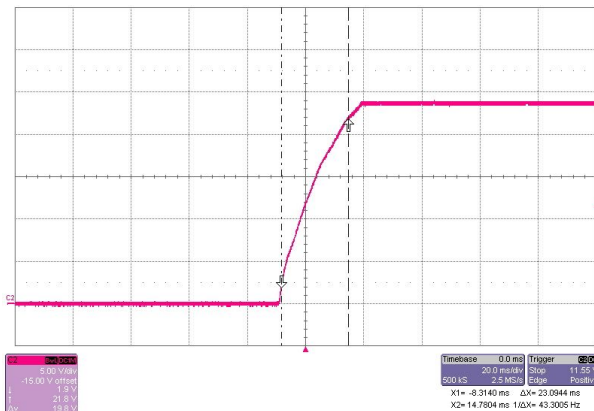

CS15-24 23.1mS

CS15 Series AC-DC Converter

Hold up Time

TEST CONDITION

- 100Vac Input
- Full Load Output
- When Input off Phase 0° or 360°, Output Voltage off Time Measure

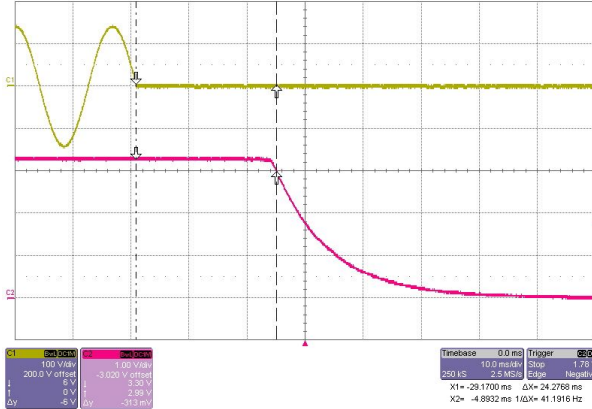

CS15-3R3 24.3ms

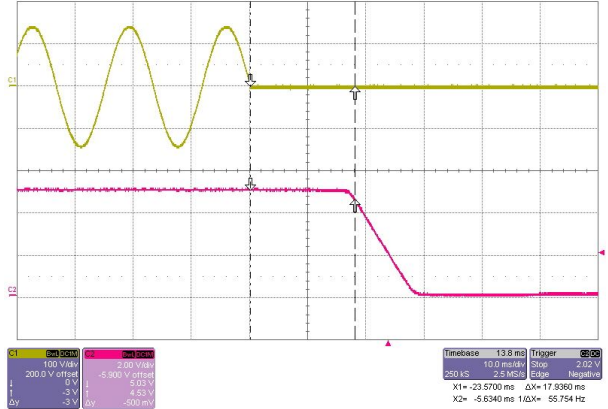

CS15-5 17.9ms

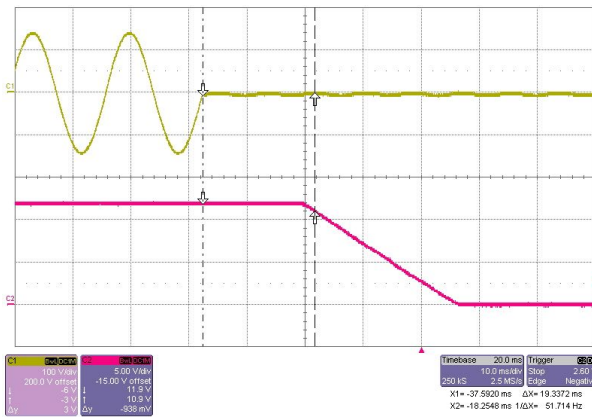

CS15-12 19.3ms

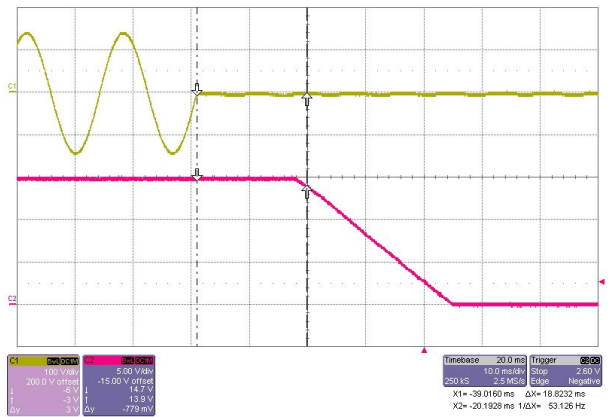

CS15-15 18.8ms

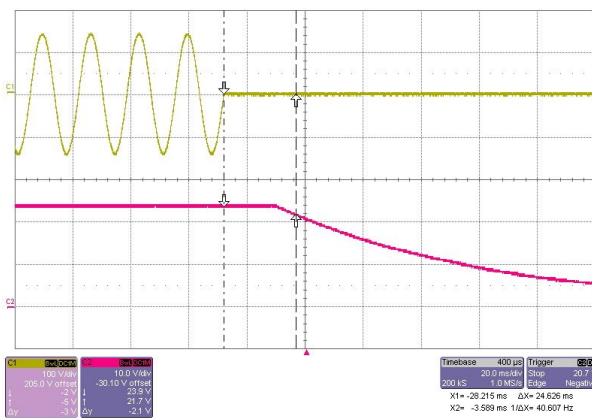

CS15-24 24.6ms

The amount of time that a power supply's output-voltage remains within the specified-voltage ranges after it's input voltage interrupts. Low rating voltage Minimum 10ms @100Vac input

CS15 Series AC-DC Converter

Start up Time

TEST CONDITION

- 100Vac Input
- Full Load Output
- When Input on Phase 360°, Output Voltage 100% rise Time Measure

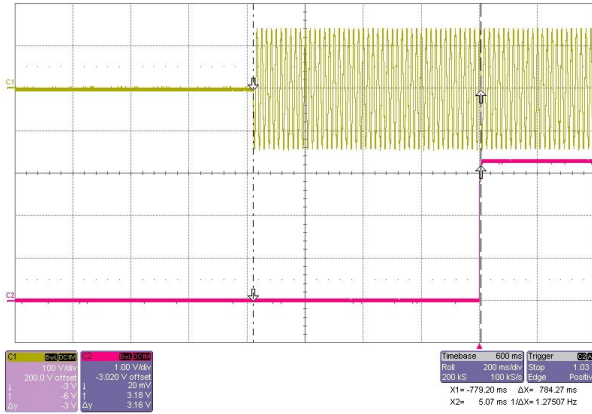

CS15-3R3 0.78S

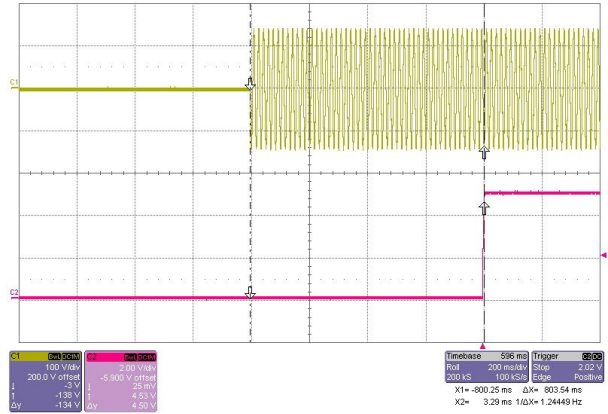

CS15-5 0.80S

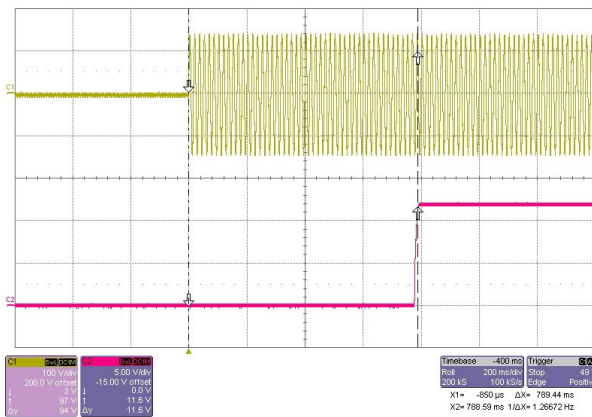

CS15-12 0.79S

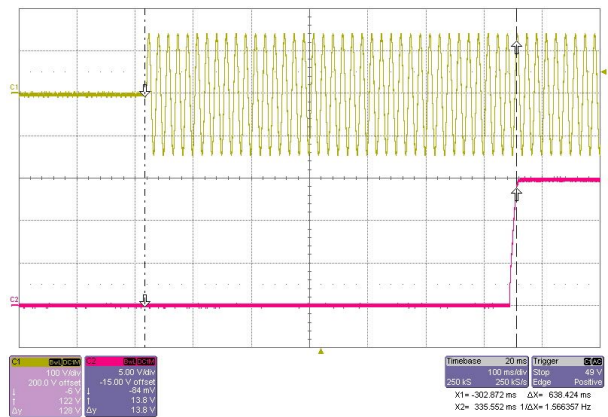

CS15-15 0.64S

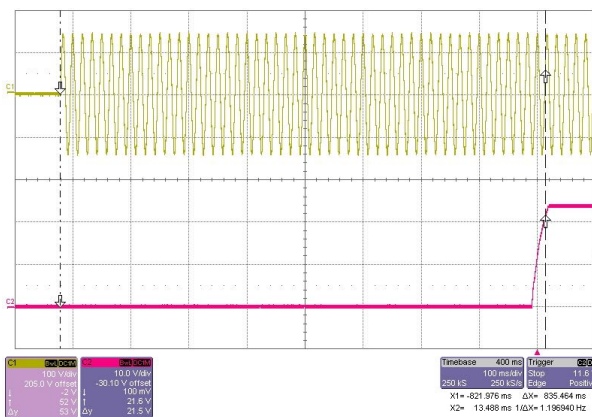

CS15-24 0.84S

Amount of delay time and rise time. After input-voltage injects.

CS15 Series AC-DC Converter

Dynamic Load Regulation

TEST CONDITION

- 100Vac Input
- 0% Load ~ 100% Load Output
- Freq. : 100Hz , - Duty : 0.5

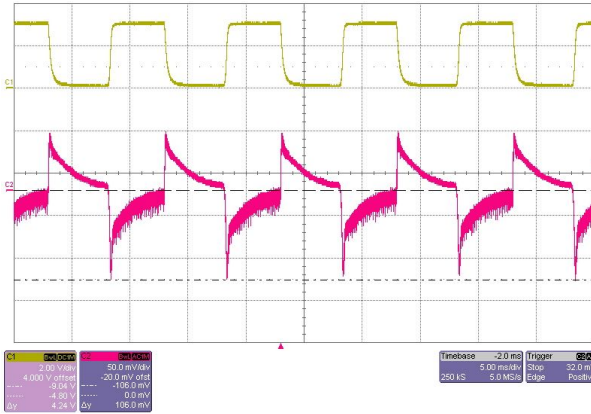

CS15-3R3 106mV

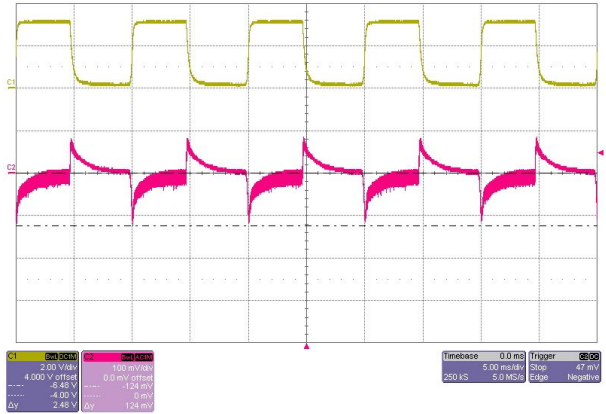

CS15-5 124mV

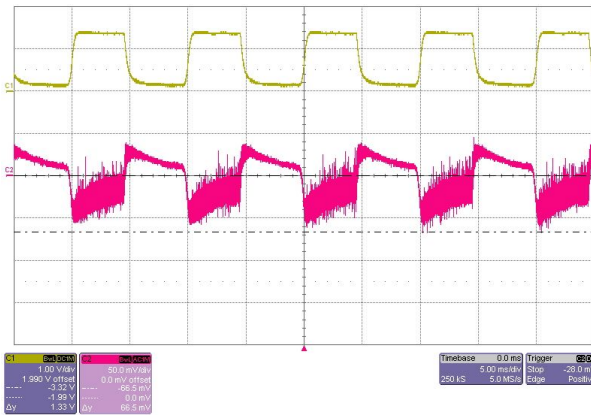

CS15-12 67mV

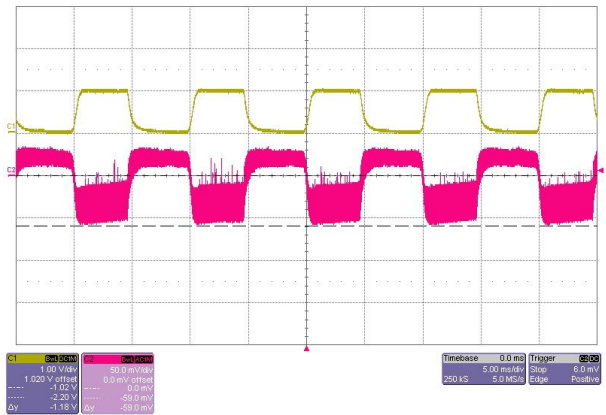

CS15-15 59mV

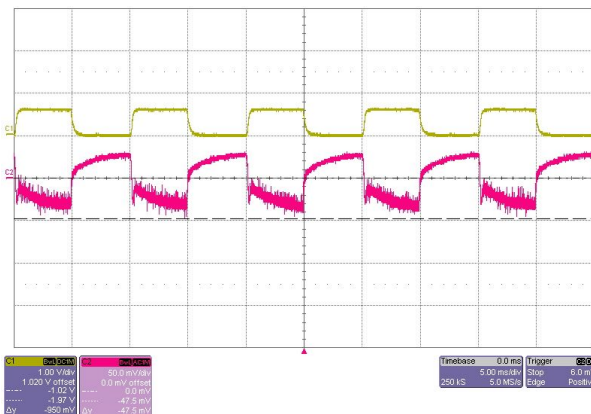

CS15-24 48mV

Considerate slew rate and frequency within $\pm 3\%$ output voltage value. Except CS15-3R3, CS15-5 are within $\pm 5\%$ output voltage value.

CS15 Series AC-DC Converter

Over Shoot

TEST CONDITION

- 240Vac Input
- Full Load Output

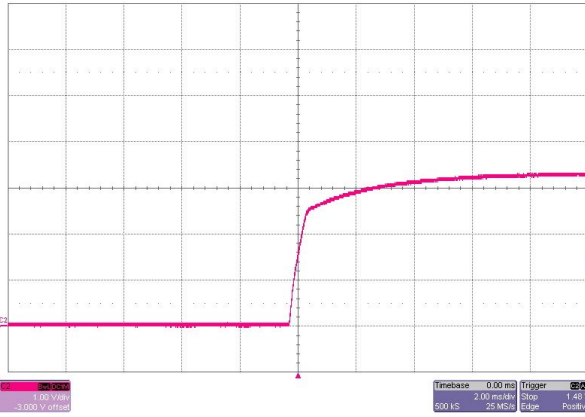

CS15-3R3 0V

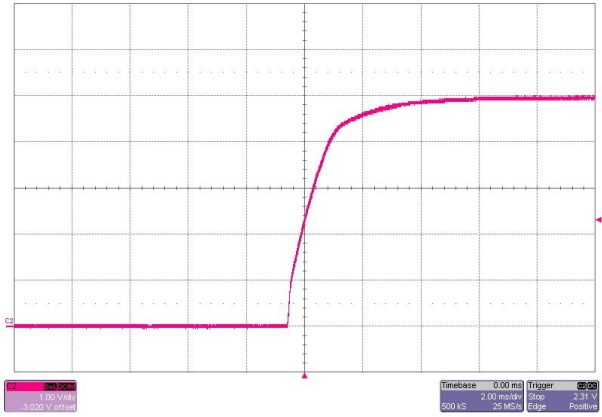

CS15-5 0V

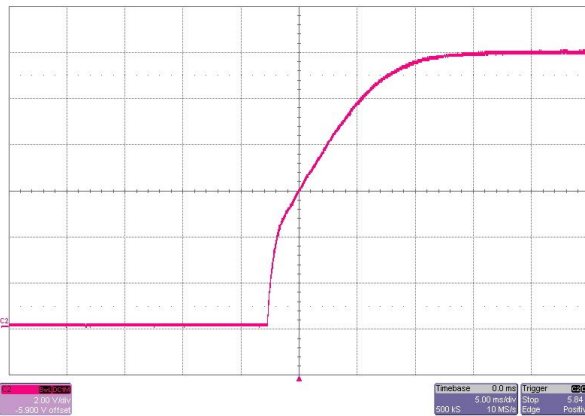

CS15-12 0V

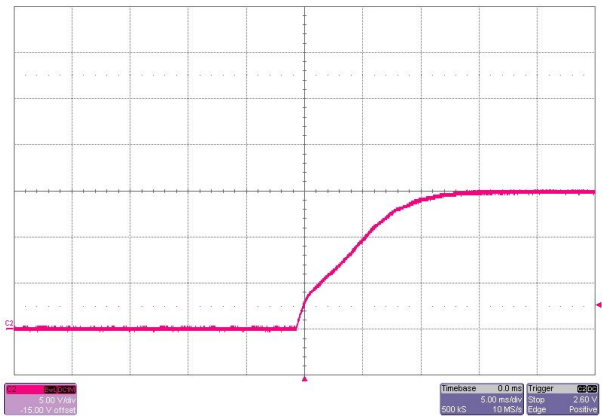

CS15-15 0V

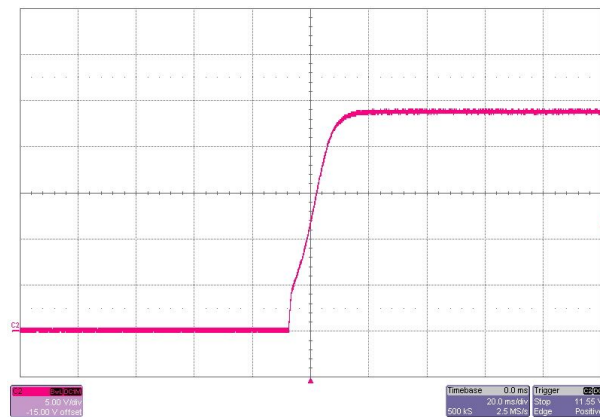

CS15-24 0V

When turn-on, the output overshoot voltage shall not exceed 5% of normal Voltage value no Load or full Load connected.

CS15 Series AC-DC Converter

Output Ripple & Noise

TEST CONDITION

- 100Vac Input
- Full Load Output
- Ele-cap(47uF)and Ceramic-cap(104), Output Terminal

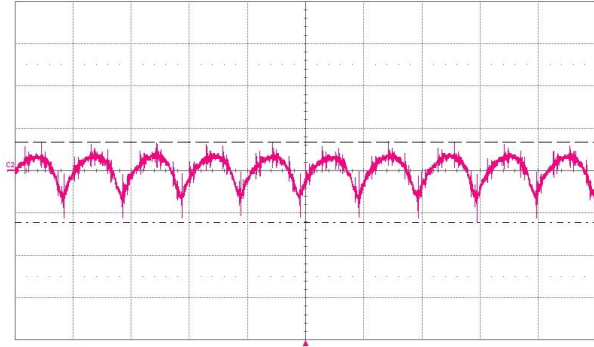

CS15-3R3 38mVpp

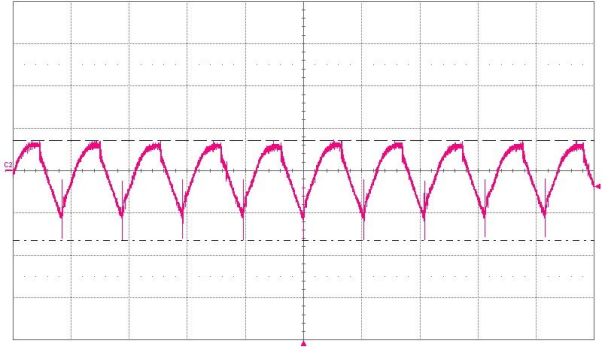

CS15-5 47mVpp

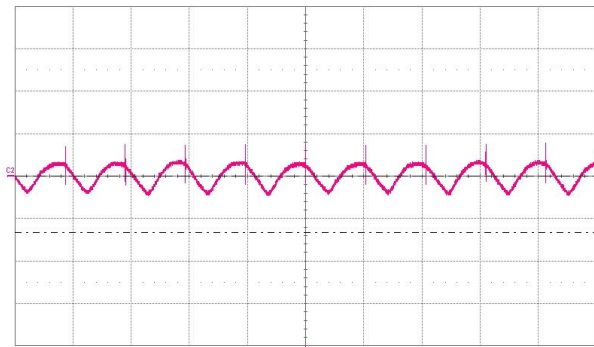

CS15-12 27mVpp

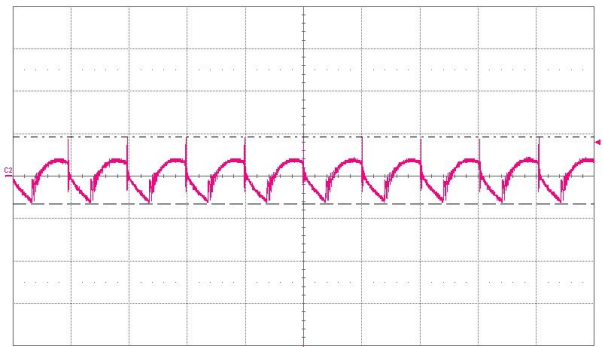

CS15-15 80mVpp

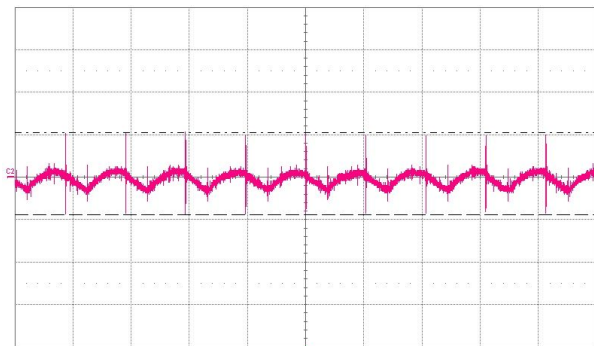

CS15-24 39mVpp

*Ripple & Noise: Oscilloscope bandwidth 20MHz.

The length of the output line should be shorter than 1meter and it needs to be twisted.

CS15 Series AC-DC Converter

Efficiency Curve(Load Variation)

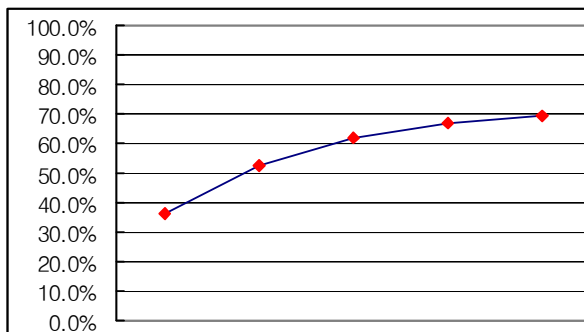

Load(%)	10	25	50	75	100
Eff(%)	36.3	52.4	61.6	66.7	69.5

CS15-3R3 / 3.3V 3.0A

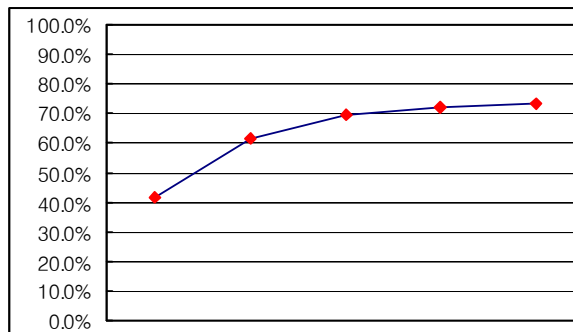

Load(%)	10	25	50	75	100
Eff(%)	41.5	61.2	69.3	71.9	73.5

CS15-5 / 5V 3.0A

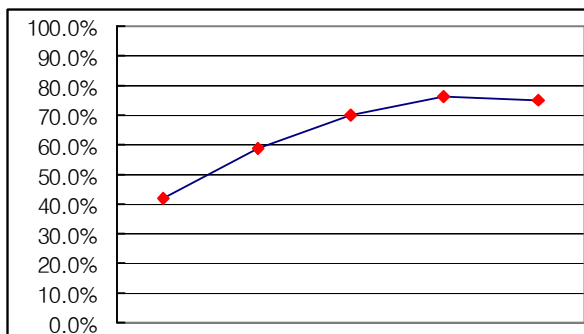

Load(%)	10	25	50	75	100
Eff(%)	41.7	59.0	70.2	76.5	75.3

CS15-12 / 12V 1.25A

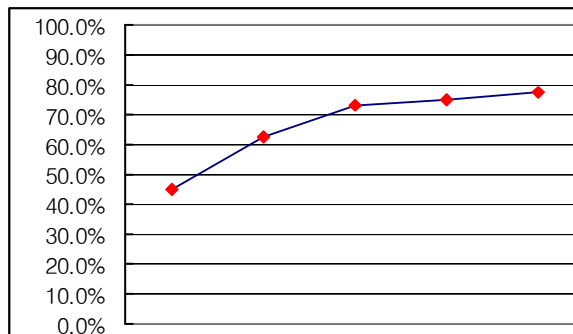

Load(%)	10	25	50	75	100
Eff(%)	44.8	62.8	72.9	75.2	77.3

CS15-15 / 15V 1.0A

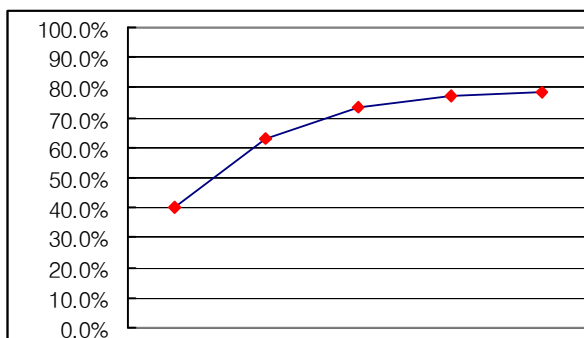

Load(%)	10	25	50	75	100
Eff(%)	40.1	62.8	73.7	77.4	78.4

CS15-24 / 24V 0.63A

Input 220Vac, Variation of efficiency, from minimum load to maximum load.

CS15 Series AC-DC Converter

Efficiency Curve(Input Voltage Variation)

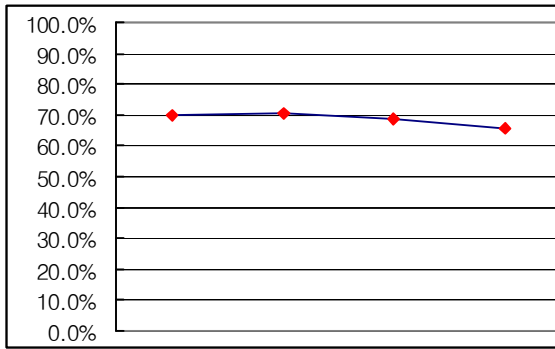

V in(V)	85	110	220	264
Eff(%)	69.9	70.7	68.7	65.6

CS15-3R3 / 3.3V 3.0A

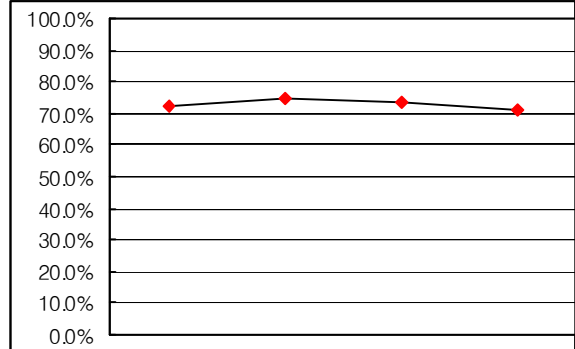

V in(V)	85	110	220	264
Eff(%)	72.2	74.4	73.2	71.3

CS15-5 / 5V 3.0A

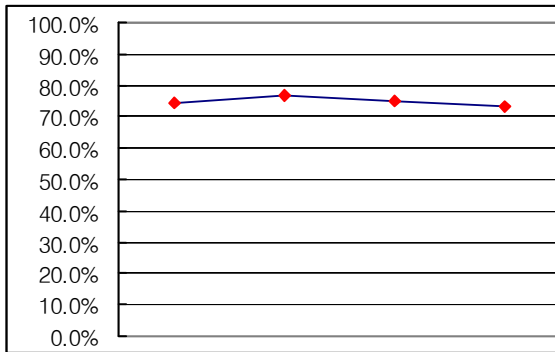

V in(V)	85	110	220	264
Eff(%)	74.7	76.9	75.1	73.2

CS15-12 / 12V 1.25A

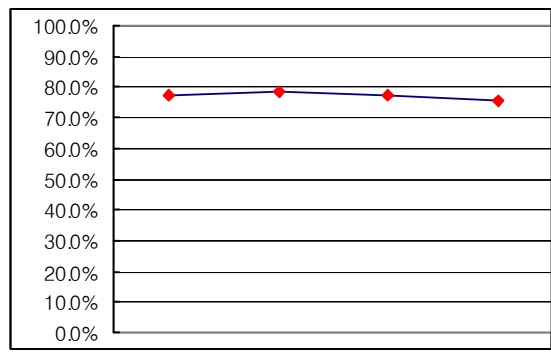

V in(V)	85	110	220	264
Eff(%)	77.2	78.7	77.5	75.6

CS15-15 / 15V 1.0A

Variation of Efficiency, from Minimum input Voltage to Maximum input Voltage

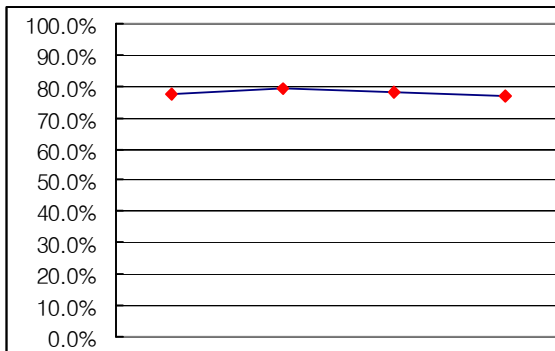

V in(V)	85	110	220	264
Eff(%)	77.7	79.4	78.2	76.8

CS15-24 / 24V 0.63A

CS15 Series AC-DC Converter

Electro Magnetic Interference Application.

CS15 Series is needs to reduce Electromagnetic Interference, use the external L-C noise filter at the input of the Converter.

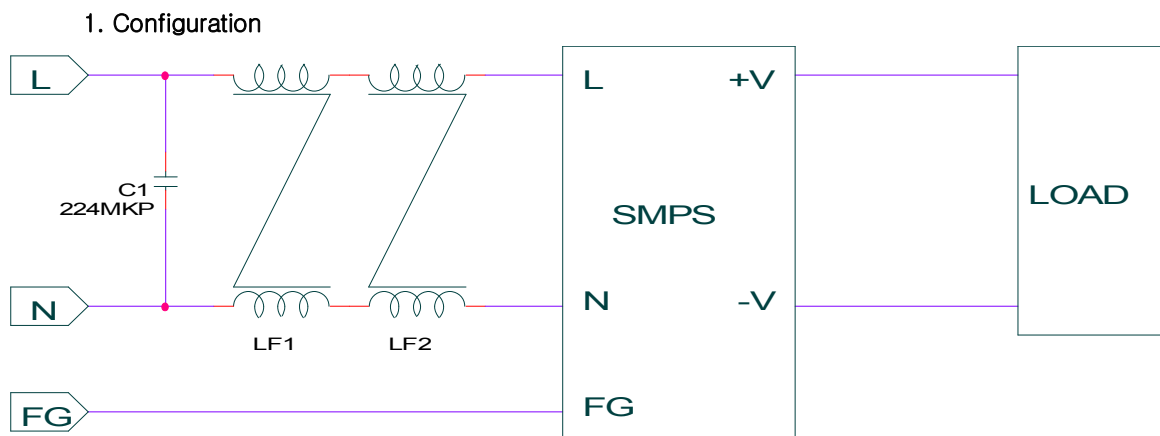

2. Components

C1 = 220nF / 275Vac, X2 Capacitor

LF1 = 20mH Common Mode Line Filter, Toroidal core ϕ 14.0mm

LF2 = 20mH Common Mode Line Filter, Toroidal core ϕ 14.0mm

CS15 Series AC-DC Converter

Calculating Reliable Values of MTBF

1. Calculating method

Calculated based on part count reliability projection of MIL-HDBK-217F Individual failure rates λ_g is given to each part and MTBF (Mean Time Between Failure) is calculated by the count of each part.

<Formula>:

$$MTBF = 1 / \lambda_{equip} = 1 / \left(\sum_{i=1}^n N_i (\lambda_G \Pi Q)_i \right) * 10^6 \text{ (Hours)}$$

λ_{equip} : Total Equipment Failure Rate (Failure/10⁶Hours)

λ_G : Generic Failure Rate for The ith Generic Part (Failure/ 10⁶Hours)

ΠQ : Generic Quality Factor for The ith Generic Part ($\Pi Q=1$)

N_i : Quantity of ith Generic Part

n : Number of Different Generic Part Categories

2. MTBF Values

MTBF \approx 219,344(Hours)

PART	Num.	Failure Rate	Failure Rate*n	Remark
	n	$\lambda_G(F/T)$	$\lambda_G \times n(F/T)$	
Logic IC	1	0.06000	0.06000	101~1000gate
Transistor, FET	1	0.49500	0.49500	IC Separate
Diode Fast Recovery, Power	3	0.12650	0.37950	
Diode Switching	1	0.00517	0.00517	
Diode (Avalanche and Zener)	1	0.01815	0.01815	
Diode LED	1	0.00259	0.00259	*4
Diode Bridge	1	0.12650	0.50600	
Voltage Regulator	1	0.02400	0.02400	
Photo-coupler	2	0.14850	0.29700	
Varistor	1	0.01595	0.01595	
Thermister	1	0.01400	0.01400	
Capacitor-ele	9	0.01900	0.17100	
Capacitor-film, MF	3	0.00700	0.02100	
Capacitor-ceramic	2	0.02600	0.05200	
Capacitor-MLCC	4	0.05300	0.21200	
Choke coil	1	0.00022	0.00022	
Transformer, Power	1	0.15900	0.15900	
Line Filter	1	0.00440	0.00440	
Resistor Volume	1	0.02400	0.02400	
Resistor Chip	19	0.01600	0.30400	
Terminal block	1	0.06200	0.31000	*5(pin)
Reflow soldering	62	0.00014	0.00868	
Flow soldering	93	0.00780	0.72540	
PCB	1	0.37000	0.74000	*2
Fuse	1	0.01000	0.01000	
Total Equipment Failure Rate $\lambda_G \times n(F/T)$			4.559055	
MTBF = $10^6 / \lambda_G(F/T)$			219343.7017	

CS15 Series AC-DC Converter

Reliability Specification	Standard	Remarks
Dry heat	IEC60068-2-2	
Cold	IEC60068-2-1	
Thermal shock	IEC60068-2-14	
Temperature, humidity cycle	IEC60068-2-30, IEC60068-2-38	
Vibration	IEC 60068-2-6	
Mechanical shock	IEC 60068-2-27	
Electrostatic Discharge immunity	IEC 61000-4-2	
Immunity to radio frequency EM-fields	IEC 61000-4-3	
Electrical fast transient/burst immunity	IEC 61000-4-4	
Surge immunity	IEC 61000-4-5	
B10 Life test	B10 Life is the time by which 10% of the product population will get failed	

CS15 Series AC-DC Converter

Instruction manual

1. Basic connection

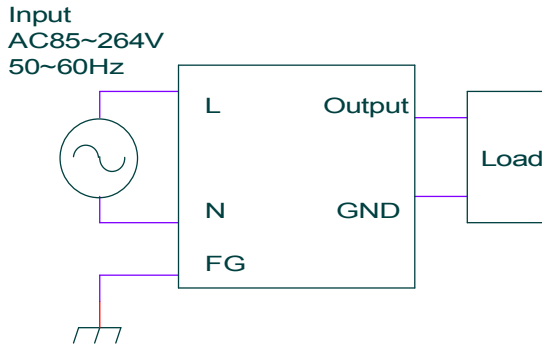

NOTE:

A: For safety as well as improved noise, ensure secure connection of the FG terminal to the ground terminal of the equipment.

B: To avoid excessive voltage drop and for improved noise, and short and thick wire should be used to connect the load. Length below 50Cm & wire thickness of 4.0A/mm² are recommended for reducing wire loss when wire connection is necessary.

2. Parallel Operation

This supply can be operated the following ways.

Choose a diode in accordance with voltage, power dissipation and heat radiation.

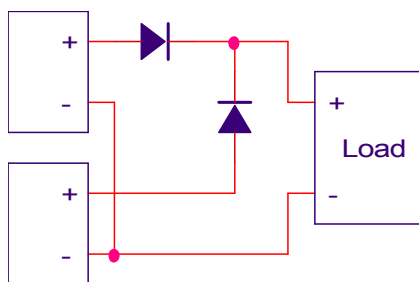

- Voltage : $V > V_o \times 3$
- Current : $I > I_o \times 3$
- Design a proper heat sink according to power loss at diode ($P_w = V_F \times I_o$)

- Use a schottky or fast recovery diode this has a low VF.

3. Series Operation

Choose a diode in accordance with voltage, power dissipation and heat radiation.

- Voltage : $V > V_o \times 3$
- Current : $I > I_o \times 3$
- Design a proper heat sink according to power loss at diode ($P_w = V_f \times I_o$).
- Use a schottky or fast recovery diode this has a low VF.

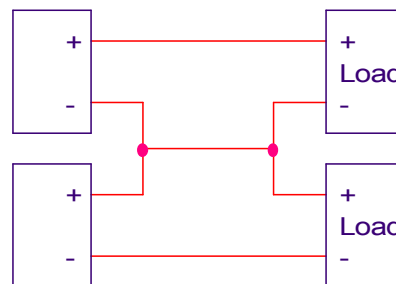
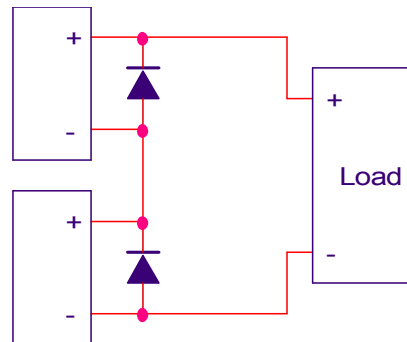

4. Over Current Protection

The CS15 Series is equipped with an over current protection circuit. When the short or overload condition is removed, the output will automatically recover. This setting is fixed and cannot be varied externally. If the short or overload condition continues, the power module could be damaged due to the heat condition.

CS15 Series AC-DC Converter

5. Over Voltage Protection

CS15 series are equipped with an over-voltage protection circuit by zener diode. If zener diode is opened, Vcc rise up, it becomes possible to implement an over voltage protection. Latch on mode. If zener diode is short, output is shorted.

It becomes possible to implement a short circuit Protection.

6. Over Temperature Protection

Temperature protection is provided by a precision analog circuit that turns the output MOSFET off when the junction temperature exceeds the thermal shutdown temperature (140°C Minimum). When the junction temperature cools to below the hysteretic temperature, normal operation resumes providing automatic recovery.

7. Line Regulation

Maximum line regulation is maximum output voltage change when the input volt is slowly varied with in the input voltage range.

8. Load Regulation

Maximum load regulation is maximum output voltage value change when varying the load current slowly within the standard output current range.

9. Isolation Resistance

The isolation resistance is more than 100MΩ at 500VDC when tested with DC isolation between the output and the case. Make sure that during testing, the isolation tester does not produce a high pulse when the applied voltage is varied. Ensure that the tester is fully discharged after the test.

10. Withstand Voltage

CS15 series are designed to withstand 3KVAC (10mA) 1 minute between input output for the withstand voltage test, 2KVAC(10mA) 1minute between input-FG , and 500VAC(10mA)1 minute between output-FG. The applied voltage must be increased gradually from zero to the testing value, and then decreased gradually at shut down.

Especially stay away from use of a timer. Where a pulse of several times the applied voltage can be generated.

INPUT-OUTPUT

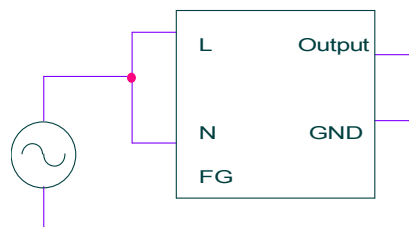

3KVAC, one minute, 10mA

INPUT-FG

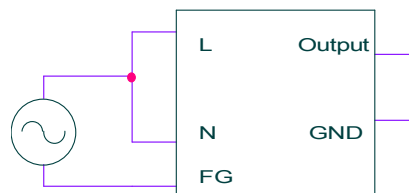

2KVAC, one minute, 10mA

OUTPUT-FG

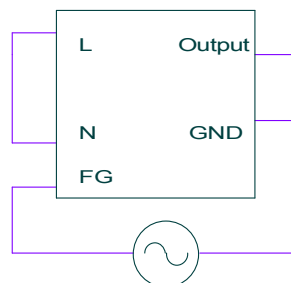

500VAC, one minute, 10mA

CS15 Series AC-DC Converter

11. Fuse rating

Rating: 250V 2.5A

Type: Time-Lag

UL/CSA or IEC approved type should be used to meet safety requirements. When changing fuse ensure that the same type and ratings used. Avoid using fast-blow fuse.

12. Block Diagrams

Circuit topology : Fly-back

Switching frequency : 100KHz(fixed)

